



SETS 24





LA CALIDAD TOTAL NOS DISTINGUE

Total quality makes the difference
La qualité totale nous différencie

ISO 90101:2015 · ISO 14001:2015 · VPA







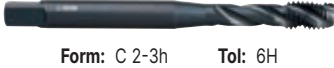
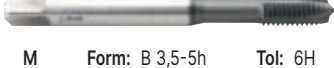

En este índice indicamos las páginas de los sets en los que se incluyen las siguientes referencias. Así mismo, hemos añadido los iconos con las propiedades más importantes para una elección adecuada. In this index you can check the pages in which the sets with the following individual products are located. We have also added important features for each product to be able to select the most suitable set. Dans cet indice on indique les pages où sont les sets qui contiennent les références suivantes. Aussi on a ajouté des icônes avec les propriétés plus importantes pour l'élection le plus convenable.

Ref.			Pág.	Ref.			Pág.
1032 New!		HSSE 5% Co	7... 20	1612		HSS Espiral Spirale Max 4 mm	22
1021		HSSE 5% Co Multi INOX	7... 21	1602		HSS Max 4 mm	22
1016		HSSE 5% Co+ TIALSIN DIN 338 N Materiales Duros Hard Materials Matériaux durs	7... 32	1622 New!		HSSE 5% Co 1/4" E6.3 Std + Imp. Driver	23
1020		HSSE 5% Co INOX	8... 29	4070		HSS-XT Serie Corta Short Length Série courte DOBLE WELDON	23
1015		HSS + ZIRKONIO DIN 338 N	7... 31	4060		HSS-XT Serie Corta Short Length Série courte UNIVERSAL: NITTO + DOBLE WELDON	23
1010		HSS + TIN DIN 338 N Uso general General Purpose Utilisation générale	7... 42	9015		MD/HM Carbure	24
1013		HSS + TIALSIN DIN 338 N Max 5 mm	7... 21	9289		MD/HM Carbure	24
1029		HSSE 5% Co DIN 338 N Alto Rendimiento Intensivo Intensive High Performance Haute Performance Intensif	7... 20	1667		HSS Max 5 mm	24
1025		HSS DIN 338 N Hélice Izquierda Left Hand Helix Hélice à gauche	8, 13	6575		PMX DIN 335 C	24
1056		HSSE 5% Co + TIALSIN DIN 1897 N Alto Rendimiento Intensivo Intensive High Performance Haute Performance Intensif	11	2571 New!		HSSE 5% Co + TIALN DIN 335 C Desplazamiento Desigual Unequal Flute Spacing Déplacement inégal	25
1050		HSS DIN 1897 N Extra-Corta Stub Extra-courte	11	2574		HSSE 5% Co + Zirkonio DIN 335 C Desplazamiento Desigual Unequal Flute Spacing Déplacement inégal	25
1637		C45	13	2575		HSSE 5% Co DIN 335 C	25
1070		HSS + TIN ANSI Std. N Rectificado Ground Taillé Meulé Pulgadas Inches Pouces	14 15	2572		HSSE 5% Co	25
1700		HSSE 5% Co NAS 907 J Rectificado Ground Taillé Meulé Pulgadas Inches Pouces	14 15	2573		HSS DIN 335 C	25
1720		HSSE 5% Co ANSI Std. Rectificado Ground Taillé Meulé Pulgadas Inches Pouces	14 15	2530		HSS DIN 373 Allen	25
1729		HSSE 5% Co DIN 338 N Rectificado Ground Taillé Meulé Pulgadas Inches Pouces	14 15	3149		HSSE 5% Co TIN DIN 371 Máquina Machine	27
1110		HSS DIN 345 N Mango Cónico Morse Taper Shank Cône morse	22	3159		HSSE 5% Co TIN DIN 371 Máquina Machine	27
1617		HSSE 5% Co Espiral Spirale Max. 4 mm	22	3110		HSSE 5% Co DIN 371 Máquina Machine	27
1607		HSSE 5% Co Max. 4 mm	22	3100		HSSE 5% Co DIN 371 Máquina Machine	28
				3150		HSSE 5% Co DIN 371 Máquina Machine	28
				3143		HSSE V DIN 371 Máquina Machine	29

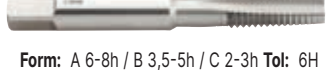















Ref.			Pág.
3153	 Form: C 2-3h Tol: 6H	HSSE V DIN 371 Máquina Machine	29
3125	 M Form: B 3,5-5h Tol: 6H	PMX + HARD DIN 371 Máquina Machine	30
3165	 M Form: C 2-3h Tol: 6H	PMX + HARD DIN 371 Máquina Machine	30
3039	 Form: A 6-8h / B 3,5-5h / C 2-3h Tol: 6H	HSS ISO 529 Mano Hand Main	31



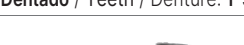

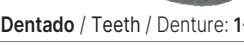

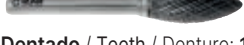



Ref.			Pág.
3536	 Tol: 6G	HSSE 5% Co M / MF DIN 22568 Mano Hand Main	34
3500	 Tol: 6G	HSS M / MF DIN 223 Mano Hand Main	34
3005	 Tol: 6G	HSS DIN 223 Mano Hand Main	34
1610		HSS DIN 3126	34

ACCESORIOS ROSCADO - Threading Accessories - Accessoires de taraudage

GIRA-MACHOS Tap Wrench Porte-taraud		32-36
GIRA-MACHOS CRIQUÉ Tap Wrench Porte-taraud		32-36
GALGA Pitch Gauge Jauge		32-36
PORTA-COJINETES Die Holder Porte-filières		32-36

INSERTO REPARACIÓN ROSCAS Thread Repair Insert Filet rapportés		32-36
MACHO PARA INSERTO REPARACIÓN ROSCAS Thread Repair Insert Tap Taraud filet rapportés		32-36
INSERTADOR Fitting Tool Appareil de pose		32-36
ROMPE ARRASTRES Pin-Breaker Rupteur		32-36

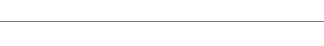
Ref.			Pág.
9260	 Dentado / Teeth / Denture: 1-3-4-6	K20 + ALTIN Tipo B Type	38
9250	 Dentado / Teeth / Denture: 1-3-4-6	K20 + ALTIN Tipo A Type	38
9251	 Dentado / Teeth / Denture: 1-3-4-6-S-M	K20 + ALTIN Tipo C Type Radial Radial Hemisférica	38
9254	 Dentado / Teeth / Denture: 1-3-4-6-M	K20 + ALTIN Tipo G Type Ojiva Tree Ogive	38
9255	 Dentado / Teeth / Denture: 1-3-4-6	MD/HM K20 Tipo M Type Cónica Cone Conique	38
9257	 Dentado / Teeth / Denture: 1-3-4-6-M	MD/HM K20 Tipo E Type Gota Oval Ovale	38
9258	 Dentado / Teeth / Denture: 1-3-4-6-M	K20 + ALTIN Tipo D Type Esférica Ball Sphérique	38
9266	 Dentado / Teeth / Denture: 1-3-4-6	MD/HM K20 Tipo H Type Llama Flame Flamme	38
9267	 Dentado / Teeth / Denture: 1-3-4-6	MD/HM K20 Tipo L Type Redondeada Ball Nosed Conique rayon	38
9268	 Dentado / Teeth / Denture: 1-3-4-6-M	K20 + ALTIN Tipo F Type Ojiva redondeada Ball Nosed Tree Ogive rayon	38

Ref.			Pág.
9016		MD/HM Carbure IZAR Std.	37
9416	 1 Z	MD/HM Carbure Micrograno+ IZAR Std. AI	37
9459	 1 Z	MD/HM Carbure 1Z Grabado Engraving Gravure	37
1891		SDS plus	40
1879		Porcelain	40
1882		Porcelain	40
1890		SDS plus	40
1876 (New!)		Una broca para TODOS los materiales One Drill Bit for ALL Materials Un foret pour TOUS les matériaux	41
1821 (New!)		MD/HM TCT	41
1886		MD/HM TCT	41
1880		MD/HM TCT	42
1836 (New!)		MD/HM Carbure Ceramic	42





Ref.			Pág.	Ref.			Pág.	
1645		HSSE 8% Co	43	3409		Extractor Tornillos Screw Extractor Extracteur vis	50	
1849			44	1520		Std	48-51	
1640		CrV	44	1621		CrV	51	
1655		CrV Maderas Duras Hard Wood Bois dur	44	1611		HSS	51	
1651			45	2940		STARLOCK	52	
1650			45	2910		STARLOCK	52	
1620		C60 Maderas Blandas Soft Wood Bois tendre	45	2930		STARLOCK Especial Special Spécial	52	
1616		HSSE 5% Co Materiales duros Hard Materials Matériaux durs	46	<p>ACEITES DE CORTE Y REFRIGERANTES Cutting Oils & Water Soluble Fluids Huiles de coupe et lubrifiants</p> <p>UNI INOX ALU Universal Heavy Duty Non Ferrous</p>				52
1613		HSS Uso general General Purpose Utilisation générale	46					
1614		HSS	47					
1834		MD/HM Carbure Ceramic	47					
1601		MD/HM TCT	47					
1529		Adaptador Adaptor Adapteur Quick Lock Inox Stainless	48-51	3415			52	
		Adaptador Adaptor Adapteur Quick Lock		8318		Cuter Hoja Partible 18 mm 18 mm Snap-Off Blade Box Cutter Cou-teau à lames rétractables 18 mm	53	
		Adaptador Magnético para Tornillos Magnetic Screw Adaptor Adaptateur magnetique pour vis		8319		Cuter Hoja Seguridad 19 mm 19 mm Security Blade Box Cutter Cou-teau à lame sécurité 19 mm	53	
3407		Extractores Impacto Impact Extractors Extracteurs impact	49	8331		18-ERG 19S-RET-TRA 19S-RET-GAN	53	

SETS PINZAS DE SUJECIÓN PARA PORTAHERRAMIENTAS
Collets for Tool-Holders Sets
Jeux pinces pour les porte-outils

Ref.		Clase/Class/Classe	DIN	Pag.	Ref.		Clase/Class/Classe	DIN	Pag.
8390		P	6499 B	54	8392		A	6499 B	54
8391		A	6499 B	54	8395		A		54



OLATU

Exclusive Packaging



▶ Video



Sets 1459

JUEGO BROCAS. 29 PCS (1-13 × 0,50 mm + Previos roscado*)
 Drill Bit Set. 29 pcs (1-13 × 0,50 mm + Before Threading sizes*)
 Jeu de forets. 29 pcs (1-13 × 0,50 mm + Pré Taraudage*)

New!



New!

Ref. 1032

N° Art. 5% Co	€
84159	



Ref. 1021

N° Art. 5% Co	€
15114	

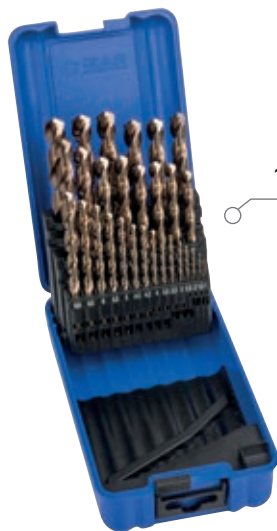

Ref. 1016

N° Art. 5% Co	€
15073	

N° Art. TIALSIN	€
15090	



Ref. 1020

N° Art. 5% Co	€
15113	

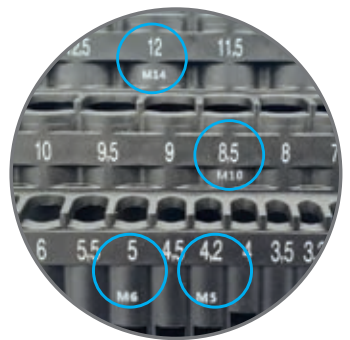

Estuche indicando los previos al roscado
Information about threading sizes on the set
 Informations concernant les mesures de pré-taraudage dans le coffret

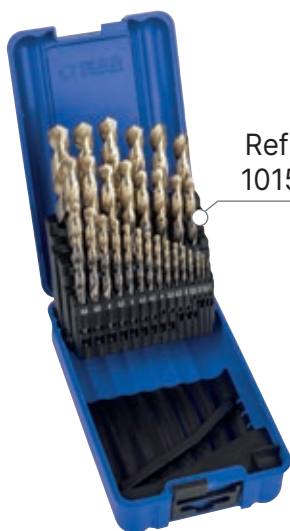

Ref. 1015

N° Art. Zirkonio	€
15115	



Ref. 1010

N° Art. HSS	€
15070	



Ref. 1013

N° Art. HSS	€
15088	

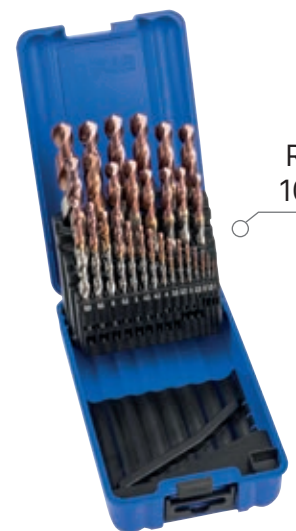

Ref. 1029

N° Art. BORDEAUX	€
15111	



Sets 1466

JUEGO BROCAS. 19 PCS. (1-10 X 0,50 mm)
 Drill Bit Set. 19 pcs. (1-10 × 0,50 mm)
 Jeu de forets. 19 pcs. (1-10 × 0,50 mm)



Ref. 1032

N° Art.	€
5% Co	
80139	



Ref. 1021

N° Art.	€
5% Co	
34201	



Ref. 1016

N° Art.	€
5% Co	
25274	



Ref. 1016
TIALSIN

N° Art.	€
TIALSIN	
14748	



Ref. 1020

N° Art.	€
5% Co	
24636	



Ref. 1015

N° Art.	€
Zirkonio	
59234	



Ref. 1010

N° Art.	€
HSS	
25271	



Ref. 1010
TIN

N° Art.	€
TIN	
27132	



Ref. 1013

N° Art.	€
HSS	
18808	



Ref. 1013
TIALSIN

N° Art.	€
TIALSIN	
38833	



Ref. 1029

N° Art.	€
BORDEAUX	
81649	



Ref. 1025



 Hélice Izquierda
 Left Hand Helix
 Hélice à gauche

N° Art.	€
HSS	
66659	

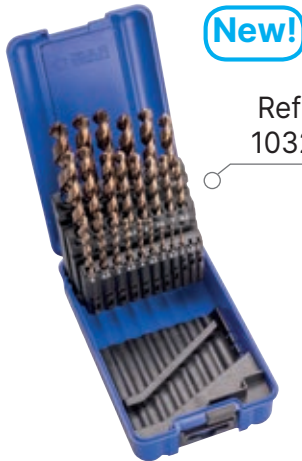

Sets 1456

JUEGO BROCAS. 25 PCS. (1-13 X 0,50 mm)
 Drill Bit Set. 25 pcs. (1-13 × 0,50 mm)
 Jeu de forets. 25 pcs. (1-13 × 0,50 mm)



New!

Ref. 1032

N° Art. 5% Co	€
34348	



Ref. 1021

N° Art. 5% Co	€
34199	

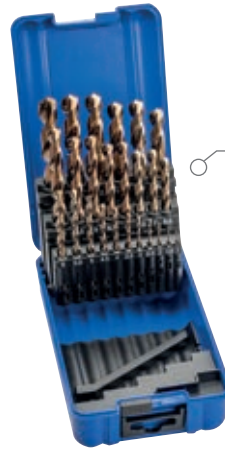

Ref. 1016

N° Art. 5% Co	€
18370	

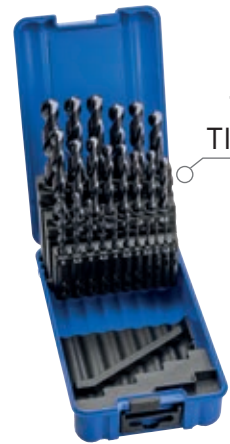

Ref. 1016 TIALSIN

N° Art. TIALSIN	€
15378	

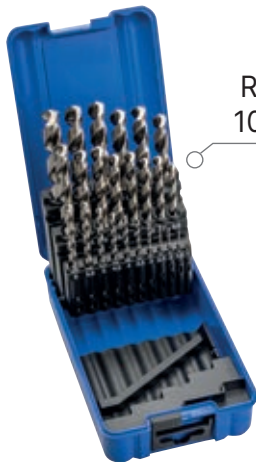

Ref. 1020

N° Art. 5% Co	€
24638	



Ref. 1015

N° Art. Zirkonio	€
59235	



Ref. 1010

N° Art. HSS	€
25235	

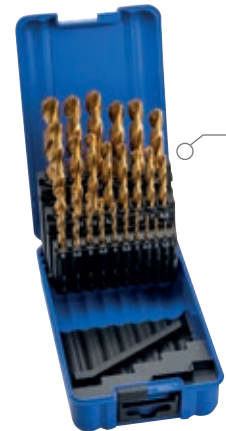

Ref. 1010 TIN

N° Art. TIN	€
27133	



Ref. 1013

N° Art. HSS	€
18807	



Ref. 1013 TIALSIN

N° Art. TIALSIN	€
38832	



Ref. 1029

N° Art. BORDEAUX	€
81687	



Display box

○ Ref. 1021



5 Sets 1466

Nº Art.	Cont. Set	€
80669	1 - 10 x 0,5 mm	

19 pcs x set

○ Ref. 1016



5 Sets 1456

Nº Art.	Cont. Set	€
80684	1 - 13 x 0,5 mm	

25 pcs x set

5 Sets 1466

Nº Art.	Cont. Set	€
80664	1 - 10 x 0,5 mm	

19 pcs x set

5 Sets 1456

Nº Art.	Cont. Set	€
80680	1 - 13 x 0,5 mm	

25 pcs x set

○ Ref. 1020



5 Sets 1466

Nº Art.	Cont. Set	€
80667	1 - 10 x 0,5 mm	

25 pcs x set

5 Sets 1456

Nº Art.	Cont. Set	€
80682	1 - 13 x 0,5 mm	

25 pcs x set

○ Ref. 1015



5 Sets 1466

Nº Art.	Cont. Set	€
80662	1 - 10 x 0,5 mm	

19 pcs x set

5 Sets 1456

Nº Art.	Cont. Set	€
80678	1 - 13 x 0,5 mm	

25 pcs x set



Display box

Ref. 1010



5 Sets 1466

Nº Art.	Cont. Set	€
79644	1 - 10 x 0,5 mm	

19 pcs x set

Ref. 1013



5 Sets 1456

Nº Art.	Cont. Set	€
80671	1 - 13 x 0,5 mm	

25 pcs x set



5 Sets 1466

Nº Art.	Cont. Set	€
80659	1 - 10 x 0,5 mm	

19 pcs x set



5 Sets 1456

Nº Art.	Cont. Set	€
80675	1 - 13 x 0,5 mm	

25 pcs x set

Sets **1476**

JUEGO BROCAS. 19 PCS. (1-10 × 0,50 mm)
 Drill Bit Set. **19 pcs.** (1-10 × 0,50 mm)
 Jeu de forets. **19 pcs.** (1-10 × 0,50 mm)

EXTRA-CORTAS
 Stubs
 Extra-courtes



Ref. 1056

Nº Art.	€
11943	



Ref. 1056
TIALSIN

Nº Art.	€
27014	



Ref. 1050

Nº Art.	€
11935	

Sets **1407**

JUEGO BROCAS. 37 PCS. (1-10 × 0,25 mm)
 Drill Bit Set. **37 pcs.** (1-10 × 0,25 mm)
 Jeu de forets. **37 pcs.** (1-10 × 0,25 mm)



Ref. 1016

Nº Art.	€
18367	



Ref. 1010

Nº Art.	€
26768	



Ref. 1010
TIN

Nº Art.	€
27134	



Sets 1408

JUEGO BROCAS. 41 PCS. (6-10 × 0,10 mm)

Drill Bit Set. 41 pcs. (6-10 × 0,10 mm)

Jeu de forets. 41 pcs. (6-10 × 0,10 mm)



Ref. 1016

N° Art.	€
5% Co	
18366	



Ref. 1015

N° Art.	€
Zirkonio	
59129	



Ref. 1010

N° Art.	€
HSS	
26771	

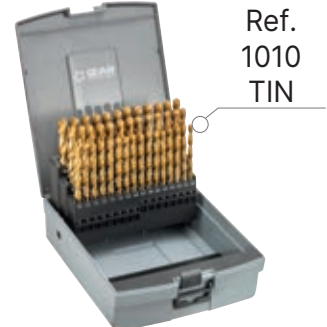

Ref. 1010 TIN

N° Art.	€
TIN	
13152	

Sets 1409

JUEGO BROCAS. 49 PCS. (1-13 × 0,25 mm)

Drill Bit Set. 49 pcs. (1-13 × 0,25 mm)

Jeu de forets. 49 pcs. (1-13 × 0,25 mm)



Ref. 1016

N° Art.	€
5% Co	
18369	



Ref. 1010

N° Art.	€
HSS	
26802	



Ref. 1010 TIN

N° Art.	€
TIN	
27135	

Sets 1405

JUEGO BROCAS. 50 PCS. (1-5,9 × 0,10 mm)

Drill Bit Set. 50 pcs. (1-5,9 × 0,10 mm)

Jeu de Forets. 50 pcs. (1-5,9 × 0,10 mm)



Ref. 1016

N° Art.	€
5% Co	
10788	



Ref. 1015

N° Art.	€
Zirkonio	
59126	



Ref. 1010

N° Art.	€
HSS	
26765	

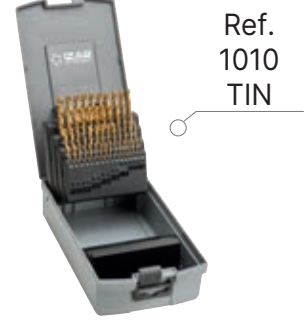

Ref. 1010 TIN

N° Art.	€
TIN	
13154	



Sets 1462

JUEGO BROCAS. 6 PCS. (2-3-4-6-8 × 0,50 mm)

Drill Bit Set. 6 pcs. (2-3-4-6-8 × 0,50 mm)

Jeu de forets. 6 pcs. (2-3-4-6-8 × 0,50 mm)



New!

Ref. 1032

Nº Art.	€
80138	



Ref. 1021

Nº Art.	€
34204	



Ref. 1016

Nº Art.	€
30231	



Ref. 1020

Nº Art.	€
25367	



Ref. 1015

Nº Art.	€
59236	



Ref. 1010

Nº Art.	€
30230	



Ref. 1013

Nº Art.	€
25365	



Ref. 1025

← Hélice Izquierda
Left Hand Helix
Hélice à gauche

Nº Art.	€
67380	

SET TOPES DE PROFUNDIDAD DE BROCAS

Drill Bit Depth Stop Set
Jeu butées de perçage

Válidos para brocas de metal y de madera
Stoppers are suitable for wood and metal drill bits
Valable pour les forets à métal et à bois

Set 1461



Nº Art.	€
79876	

13
pcs

Brocas Metal
Metal Drill Bits
Forets métal
3-4-5-6-8-10 mm

Llave Allen
Allen Wrench
Clé Allen 1 pc

Topes de profundidad - Depth Stops - Butées de perçage
3-4-5-6-8-10 mm



Set 1637

New!



6 Sets

Nº Art.	€
13768	



6 Pcs

Cont. Ø	Nº Art.	€
3-4-5-6-8-10 mm	81689	



Pulgadas -Inches -Pouces

Sets **1493**

JUEGO BROCAS. 13 PCS. (1/16 - 1/4 × 1/64)

Drill Bit Set. **13 pcs.** (1/16 - 1/4 × 1/64)

Jeu de forets. **13 pcs.** (1/16 - 1/4 × 1/64)



Ref.
1070

N° Art.	€
HSS 13065	



Ref.
1070
TIN

N° Art.	€
TIN 14279	

* Art. bajo demanda
upon request
sur demande



Ref.
1700

N° Art.	€
Cobalt 14280	

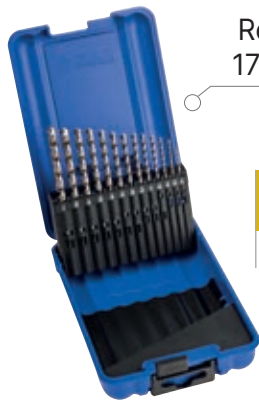

Ref.
1720

New!

N° Art.	€
Cobalt 75841	



Ref.
1729

New!

N° Art.	€
BORDEAUX 12081	

Sets **1495**

JUEGO BROCAS. 15 PCS. (1/16 - 1/2 × 1/32)

Drill Bit Set. **15 pcs.** (1/16 - 1/2 × 1/32)

Jeu de forets. **15 pcs.** (1/16 - 1/2 × 1/32)



Ref.
1070

N° Art.	€
HSS 13067	

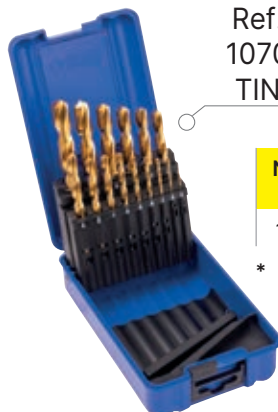

Ref.
1070
TIN

N° Art.	€
TIN 19230	

* Art. bajo demanda
upon request
sur demande



Ref.
1700

N° Art.	€
Cobalt 14272	



Ref.
1720

New!

N° Art.	€
Cobalt 75842	



Ref.
1729

New!

N° Art.	€
BORDEAUX 12091	



Pulgadas -Inches -Pouces

Sets **1496**

JUEGO BROCAS. 29 PCS. (1/16 - 1/2 × 1/64)

Drill Bit Set. **29 pcs.** (1/16 - 1/2 × 1/64)

Jeu de forets. **29 pcs.** (1/16 - 1/2 × 1/64)



Ref.
1070

N° Art. HSS	€
20423	



Ref.
1070
TIN

N° Art. TIN	€
19231	

* Art. bajo demanda
upon request
sur demande

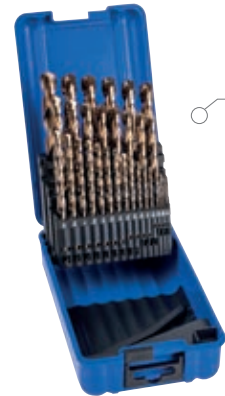

Ref.
1700

N° Art. Cobalt	€
14271	



Ref.
1720

New!

N° Art. Cobalt	€
75844	



Ref.
1729

New!

N° Art. BORDEAUX	€
12095	

New!

NOVABOX

Ref. 1410



Medir y ubicar las brocas en un solo movimiento
Gauge and place the drills in one single movement
Mesurer et classer les forets en une seule course



Sujeción a la pared
Holding on the wall
Fixation dans le mur

- Almacene y trabaje con este juego de 55 brocas para metal
- Manejo fácil para colocar las brocas en los huecos correspondientes
- Posibilidad de colgar en la pared gracias al colgador trasero
- Storage and management in a 55 metalworking drill set
- Easy use to put drills in suitable socket
- Possibility to hang on the wall
- Stockez et travaillez avec ce jeu de 55 forets
- Utilisation facile pour ranger les forets dans le trou correspondant
- Possibilité d'accrocher au mur grâce au crochet arrière

Contenido:
Content:
Contenu:

55
pcs

- Ø1,0 – 4,0 mm: 3 piezas pieces pièces
- Ø4,2 – 8,0 mm: 2 piezas pieces pièces
- Ø8,50 – 13,0 mm: 1 pieza pieces pièces

Agujeros para:

- Brocas desde 1 a 13 mm x 0,5 mm
- Incluye los siguientes diámetros previos al roscado:
Ø2,5 / 3,3 / 4,2 / 5,0 / 6,8 / 8,5 / 10,2 / 12,0 mm para las métricas de roscado
M3 / M4 / M5 / M6 / M8 / M10 / M12 / M14

Holes for:

- Drill diameters from 1 to 13 mm x 0,5 mm
- Includes core hole sizes:
Ø2,5 / 3,3 / 4,2 / 5,0 / 6,8 / 8,5 / 10,2 / 12,0 mm for threading dimensions
M3 / M4 / M5 / M6 / M8 / M10 / M12 / M14

Trous pour:

- Forets de 1 à 13 mm x 0,5 mm
- Inclut les diamètres suivantes pré-taraudage:
Ø2,5 / 3,3 / 4,2 / 5,0 / 6,8 / 8,5 / 10,2 / 12,0 mm pour les métriques de taraudage
M3 / M4 / M5 / M6 / M8 / M10 / M12 / M14





Ref. **1016** **BROCA MANGO CILÍNDRICO COBALTO**
Cobalt Straight Shank Drill Bit
Foret queue cylindrique Cobalt



PROFESSIONAL

55 Pcs

Cont. Ø	Nº Art.	€
1 - 13 x 0,5 mm	19537	



Ref. **1015** **BROCA MANGO CILÍNDRICO ZIRKONIO**
Zirkonio Straight Shank Drill Bit
Foret queue cylindrique Zirkonio



ZIRKON

55 Pcs

Cont. Ø	Nº Art.	€
1 - 13 x 0,5 mm	28360	



Ref. **1010** **BROCA MANGO CILÍNDRICO HSS**
HSS Straight Shank Drill Bit
Foret queue cylindrique HSS



CLASSIQUE

55 Pcs

Cont. Ø	Nº Art.	€
1 - 13 x 0,5 mm	19535	



Ref. **1013** **BROCA MANGO CILÍNDRICO HSS SPEED POINT**
Speed Point HSS Straight Shank Drill Bit
Foret queue cylindrique HSS Speed Point



SPEED POINT

55 Pcs

Cont. Ø	Nº Art.	€
1 - 13 x 0,5 mm	19536	

Sets 1406

JUEGO BROCAS. 91 PCS. (1-10 X 0,10 mm)
 Drill Bit Set. **91 pcs.** (1-10 × 0,10 mm)
 Jeu de forets. **91 pcs.** (1-10 × 0,10 mm)



Ref.
1016

N° Art. 5% Co	€
56686	

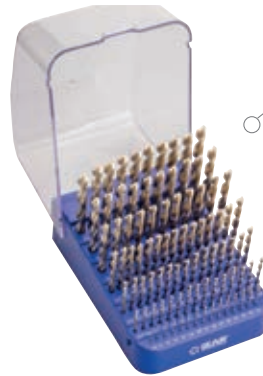

Ref.
1015

N° Art. Zirkonio	€
66483	



Ref.
1010

N° Art. HSS	€
56685	



Ref.
1013

N° Art. HSS	€
60624	

Sets 1404

JUEGO BROCAS 99 PCS (1-10×0,1mm + 10-13×0,5mm + Previos roscado 10-13mm)
 Drill Bit Set. **99 pcs.** (1-10×0,1mm + 10-13×0,5mm + Before Threading sizes 10-13mm)
 Jeu de forets. **99 pcs.** (1-10×0,1mm + 10-13×0,5mm + Pré Taraudage 10-13mm)

New!



Ref.
1016

N° Art. 5% Co	€
48821	



Ref.
1015

N° Art. Zirkonio	€
48824	



Ref.
1010

N° Art. HSS	€
48815	

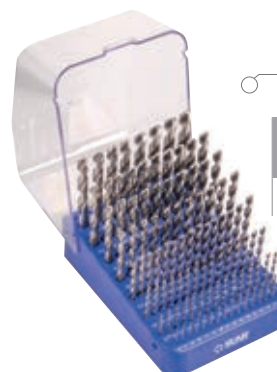

Ref.
1013

N° Art. HSS	€
48818	



Sets **1470**

SETS BROCAS

Drill Bit Set
Jeu de forets

170 Pcs: 1-10 × 0,5 mm
 ø 1-8: 10 pcs/ø
 ø 8,5-10: 5 pcs/ø



Ref.
1016

N° Art. 5% Co	€
10676	



Ref.
1010

N° Art. HSS	€
19590	



Ref.
1013

N° Art. HSS	€
56677	

220 Pcs: 1-13 × 0,5 + 3,3 + 4,2 mm
 ø 1-8: 10 pcs/ø
 ø 8,5-13: 5 pcs/ø



Ref.
1016

N° Art. 5% Co	€
25391	



Ref.
1010

N° Art. HSS	€
56676	



Ref.
1013

N° Art. HSS	€
56679	

New Exhibitors!



Sets **1029**
BROCA MULTI ACERO
 Multi-Steel Drill Bit
 Foret multi-acier

New!



Ø mm	Uds	Ø mm	Uds	Ø mm	Uds
1,00	10	5,50	10	10,00	10
1,50	10	6,00	10	10,50	5
2,00	10	6,50	10	11,00	5
2,50	10	7,00	10	11,50	5
3,00	10	7,50	10	12,00	5
3,50	10	8,00	10	12,50	5
4,00	10	8,50	10	13,00	5
4,50	10	9,00	10		
5,00	10	9,50	10		

220 Pcs

N° Art.	€
BORDEAUX	
41037	

Set **1032**
BROCA COBALTO METALMAX
 METALMAX Cobalt Drill Bit
 Foret cobalt METALMAX

New!



Ø mm	Uds	Ø mm	Uds	Ø mm	Uds
1,00	10	5,50	10	10,00	10
1,50	10	6,00	10	10,50	5
2,00	10	6,50	10	11,00	5
2,50	10	7,00	10	11,50	5
3,00	10	7,50	10	12,00	5
3,50	10	8,00	10	12,50	5
4,00	10	8,50	10	13,00	5
4,50	10	9,00	10		
5,00	10	9,50	10		

220 Pcs

N° Art.	€
HSSE	
41034	

Sets 1021

BROCA MULTI INOX
Multi-STAINLESS Drill Bit
Foret Multi INOX



Ø mm	Uds	Ø mm	Uds	Ø mm	Uds
1,00	10	5,50	10	10,00	5
1,50	10	6,00	10	10,50	1
2,00	10	6,50	10	11,00	1
2,50	10	7,00	10	11,50	1
3,00	10	7,50	10	12,00	1
3,50	10	8,00	10	12,50	1
4,00	10	8,50	5	13,00	1
4,50	10	9,00	5		
5,00	10	9,50	5		

176 Pcs

N° Art.
HSSE

€

55448

Sets 1016

BROCA MATERIALES DUROS
Hard Materials Drill Bit
Foret matériaux durs



Ø mm	Uds	Ø mm	Uds	Ø mm	Uds
1,00	10	5,50	10	10,00	10
1,50	10	6,00	10	10,50	5
2,00	10	6,50	10	11,00	5
2,50	10	7,00	10	11,50	5
3,00	10	7,50	10	12,00	5
3,50	10	8,00	10	12,50	5
4,00	10	8,50	10	13,00	5
4,50	10	9,00	10		
5,00	10	9,50	10		

220 Pcs

N° Art.
HSSE

€

55449

Sets 1020

BROCA INOX
Stainless Steel Drill Bit
Foret Inoxydable



Ø mm	Uds	Ø mm	Uds	Ø mm	Uds
1,00	10	5,50	10	10,00	5
1,50	10	6,00	10	10,50	5
2,00	10	6,50	10	11,00	5
2,50	10	7,00	10	11,50	5
3,00	10	7,50	10	12,00	5
3,50	10	8,00	10	12,50	5
4,00	10	8,50	5	13,00	5
4,50	10	9,00	5		
5,00	10	9,50	5		

200 Pcs

N° Art.
HSSE

€

55446

Sets 1015

BROCA ZIRKONIO
Zirkonio Drill Bit
Foret Zirkonio



Ø mm	Uds	Ø mm	Uds	Ø mm	Uds
1,00	10	5,50	10	10,00	5
1,50	10	6,00	10	10,50	5
2,00	10	6,50	10	11,00	5
2,50	10	7,00	10	11,50	5
3,00	10	7,50	10	12,00	5
3,50	10	8,00	10	12,50	5
4,00	10	8,50	5	13,00	5
4,50	10	9,00	5		
5,00	10	9,50	5		

200 Pcs

N° Art.
Zirkonio

€

14229

Sets 1010

BROCA USO GENERAL
General Purpose Drill Bit
Foret utilisation générale



Ø mm	Uds	Ø mm	Uds	Ø mm	Uds
1,00	10	5,50	10	10,00	10
1,50	10	6,00	30	10,50	5
2,00	20	6,50	10	11,00	5
2,50	20	7,00	10	11,50	5
3,00	50	7,50	10	12,00	5
3,50	30	8,00	20	12,50	5
4,00	40	8,50	10	13,00	5
4,50	20	9,00	10		
5,00	40	9,50	10		

400 Pcs

N° Art.
HSS

€

55440

Sets 1013

BROCA AGUZADA
Split Point Drill Bit
Foret affutage en croix



Ø mm	Uds	Ø mm	Uds	Ø mm	Uds
1,00	10	5,50	10	10,00	5
1,50	10	6,00	30	10,50	5
2,00	20	6,50	10	11,00	5
2,50	20	7,00	10	11,50	5
3,00	40	7,50	10	12,00	5
3,50	20	8,00	20	12,50	5
4,00	40	8,50	5	13,00	5
4,50	20	9,00	5		
5,00	30	9,50	5		

350 Pcs

N° Art.
HSS

€

55443

Sets 1110

BROCA MANGO CÓNICO HSS. SERIE CORTA

HSS Morse Taper Shank Drill Bit. Jobber Series
Foret queue cône morse HSS. Série courte



25 Pcs

Cont. Ø	N° Art. HSS	€
14-14,5-15-15,5-16-16,5-17-17,5-18-18,5-19-19,5-20-20,5-21-21,5-22-22,5-23-24-25-26-27-28-30 mm	14263	



10 Pcs

Cont. Ø	N° Art. HSS	€
14-15-16-17-18-19-20-21-22-25 mm	19346	

Set 1617

BROCA ESCALONADA ESPIRAL HSSE INOX

Stainless HSSE Spiral Step Drill Bit
Foret étagé spirale HSSE Inox



3 Pcs

Cont.	N° Art. 5%Co	€
4-12, 4-20, 6-30 mm	67317	

Set 1607

BROCA ESCALONADA HSSE INOX

Stainless HSSE Step Drill Bit
Foret étagé HSSE Inox



3 Pcs

Cont.	N° Art. 5%Co	€
4-12, 4-20, 6-30 mm	43519	

Set 1612

BROCA ESCALONADA ESPIRAL HSS

HSS Spiral Step Drill Bit
Foret étagé spirale HSS



3 Pcs

Cont.	N° Art. HSS	€
4-12, 4-20, 6-30 mm	67357	

Set 1602

BROCA ESCALONADA HSS

HSS Step Drill
Foret étagé HSS



3 Pcs

Cont.	N° Art. HSS	€
4-12, 4-20, 6-30 mm	43518	



Set **1622**

BROCA ESCALONADA ESPIRAL MANGO E6.3

E6.3 Shank Spiral Step Drill Bit
Foret étagé spirale queue E6.3

New!



3 Pcs

Cont.	Nº Art.	€
4-12, 4-20, 6-30 mm	86553	

Sets **4070**

FRESA HUECA MÁQUINAS ELECTROMAGNÉTICAS HSS-XT CORTA

Short HSS-XT Annular Cutter Core Drill

Fraise à carotter pour unité de perçage électromagnétique HSS-XT courte

DOBLE WELDON

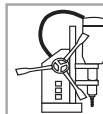

MÁQUINAS ELECTROMAGNÉTICAS
Electromagnetic Machines
Machines électromagnétiques



6 Pcs

Cont. Ø	Nº Art. HSS	€
12-14-16-18-20-22	66858	



5 Pcs

Cont. Ø	Nº Art. HSS	€
24-26-28-30-32	66859	

Sets **4060**

FRESA HUECA MÁQUINAS ELECTROMAGNÉTICAS HSS-XT CORTA

Short HSS-XT Annular Cutter Core Drill

Fraise à carotter pour unité de perçage électromagnétique HSS-XT courte

UNIVERSAL: NITTO + WELDON

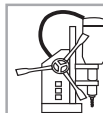

MÁQUINAS ELECTROMAGNÉTICAS
Electromagnetic Machines
Machines électromagnétiques



6 Pcs

Cont. Ø	Nº Art. HSS	€
12-14-16-18-20-22	66860	



5 Pcs

Cont. Ø	Nº Art. HSS	€
24-26-28-30-32	66861	



Set 9015

SET CERRAJEROS

Locksmith Set
Jeu serruriers

New!



Ref. 9015



Ref. 9289



4 Pcs

Cont.	Nº Art.	€
Ref. 9015: ø 6 mm Ref. 9289: ø 3-4-6 mm	53879	

Ref. 9015



- Metal Duro monoblock de última generación
- Punta auto centrante
- Afilado especial IZAR
- Precisión y buen acabado
- Apto para bombillos de latón y acero o bombillos de seguridad.
- Last generation monoblock Solid Carbide
- Autocentering point
- IZAR special Sharpening
- Good Precision and Finishing
- Suitable for brass, steel or security cylinder locks
- Carbure monoblock dernière génération
- Pointe autocentrante
- Affûtage spéciale IZAR
- Précision et bonne qualité de finition
- Conçu pour serrure en laiton et acier ou serrure de sécurité

Set 1667

CORONA REAFILABLE HSS
HSS Resharpenable Hole Saw
Fraise réaffûtable HSS



6 Pcs

Cont. Ø	Nº Art.	€
12-14-16-18-20-22	77448	

SETS AVELLANADO
Countersinking-Counterboring
Fraisage

Set 6575

AVELLANADOR PMX 90°
MATERIALES MUY DUROS

Very Hard Materials 90° PMX
Countersink

Fraise à noyer PMX 90° matériaux très durs



6 Pcs

Cont. Ø	Nº Art. PMX	€
6,3-8,3-10,4-12,4-16,5-20,5	65518	





Set **2571** New!

AVELLANADOR ANTIVIBRACIÓN 3Z HELICOIDAL DESPLAZAMIENTO DESIGUAL

Unequal Flute Spacing Spiral **Anti-Vibration 3Z** Countersink
Fraise à noyer **anti-vibration 3Z** helicoidal desplazamiento desigual

6 Pcs Set Price!

Cont. Ø	Nº Art TIALN	€
6,3-8,3-10,4-12,4-16,5-20,5	85218	



Set **2574** New!

AVELLANADOR ANTIVIBRACIÓN 3Z DESPLAZAMIENTO DESIGUAL

Unequal Flute Spacing **Anti-Vibration 3Z** Countersink
Fraise à noyer **anti-vibration 3Z** déplacement inégal

6 Pcs Set Price!

Cont. Ø	Nº Art. Zirkonio	€
6,3-8,3-10,4-12,4-16,5-20,5	16943	
	85219	

* Mango liso hasta fin de existencias
Plain Shank while stock lasts
Queue plane jusqu'à la fin de stock



Set **2575**

AVELLANADOR MANGO CILÍNDRICO HSSE 3Z 90°

90° 3Z HSSE Straight Shank Countersink
Fraise à noyer HSSE 3Z 90°

6 Pcs

Cont. Ø	Nº Art. 5% Co	€
6,3-8,3-10,4-12,4-16,5-20,5	40515	



Set **2572**

AVELLANADOR MANGO CILÍNDRICO HSSE AGUJERO 90°

90° Hole HSSE Straight Shank Countersink
Fraise à ebavurer HSSE trou 90°

4 Pcs

Aplic. mm	Nº Art. 5% Co	€
2-5, 5-10, 10-15, 15-20	40513	



Set **2573** New!

AVELLANADOR MANGO CILÍNDRICO HSS 1Z 90°

90° 1Z HSS Straight Shank Countersink
Fraise à noyer HSS 1Z 90°

6 Pcs

Cont.	Nº Art. HSS	€
6-8-10-12-16-20	62985	

Set **2530**



AVELLANADOR MANGO CILÍNDRICO ALLEN

Allen Straight Shank Counterbore
Fraise à lamer et chambrer

6 Pcs

Cont.	Nº Art. HSS	€
M3-M4-M5-M6-M8-M10	40512	

+ info: Cat. IND-24





SETS MACHOS

Tap Sets
Jeux de tarauds



Sets
3149-3159

MACHO MÁQUINA MÉTRICA INOX MANGO REFORZADO

Reinforced Shank **Stainless** Metric Machine Tap

Taraud machine métrique **inox** queue renforcée

New!

Ref. 3149 + 1016 HSSE **MACHO RECTO**
Straight Tap
Taraud Droit



14 Pcs

Cont.	N° Art. TIN	€
Machos / Taps / Tarauds DIN 371: M3-M4-M5-M6-M8-M10-M12	77303	Set Price!
Brocas / Drill Bits / Forets 1016 HSSE: 2,5-3,3-4,2-5,0-6,8-8,5-10,2		

Ref. 3159 + 1016 HSSE **MACHO HELICOIDAL**
Spiral Tap
Taraud Helicoïdal



14 Pcs

Cont.	N° Art. TIN	€
Machos / Taps / Tarauds DIN 371: M3-M4-M5-M6-M8-M10-M12	77304	Set Price!
Brocas / Drill Bits / Forets 1016 HSSE: 2,5-3,3-4,2-5,0-6,8-8,5-10,2		

Sets
3110

MACHO RECTO MÁQUINA MÉTRICA MANGO REFORZADO

Reinforced Shank Metric Machine Straight Tap

Taraud droit machine métrique queue renforcée

Ref. 3110



7 Pcs

Cont.	N° Art. 5% Co	€
Machos / Taps / Tarauds DIN 371: M3-M4-M5-M6-M8-M10 + DIN 376: M12	43351	

Ref. 3110 + 1010 HSS



14 Pcs

Cont.	N° Art. HSS	€
Machos / Taps / Tarauds DIN 371: M3-M4-M5-M6-M8-M10 + DIN 376: M12	43357	
Brocas / Drill Bits / Forets HSS: 2,5-3,3-4,2-5,0-6,8-8,5-10,2		

Ref. 3110 + 1016 HSSE



14 Pcs

Cont.	N° Art. 5% Co	€
Machos / Taps / Tarauds DIN 371: M3-M4-M5-M6-M8-M10 + DIN 376: M12	16198	
Brocas / Drill Bits / Forets HSSE: 2,5-3,3-4,2-5,0-6,8-8,5-10,2		

Sets 3100

MACHO RECTO MÁQUINA MÉTRICA MANGO REFORZADO

Reinforced Shank Metric Machine Straight Tap

Taraud droit machine métrique queue renforcée



Ref. 3100

7 Pcs

Cont.	N° Art. 5% Co	€
Machos Taps / Tarauds DIN 371: M3-M4-M5- M6-M8-M10 + DIN 376: M12	43348	



Ref. 3100 + 1010 HSS

14 Pcs

Cont.	N° Art. HSS	€
Machos Taps / Tarauds DIN 371: M3-M4-M5- M6-M8-M10 + DIN 376: M12	43354	
Brocas Drill Bits / Forets HSS: 2,5-3,3-4,2-5,0- 6,8-8,5-10,2		



Ref. 3100 + 1016 HSSE

14 Pcs

Cont.	N° Art. 5% Co	€
Machos Taps / Tarauds DIN 371: M3-M4-M5- M6-M8-M10 + DIN 376: M12	21801	
Brocas Drill Bits / Forets HSSE: 2,5-3,3-4,2- 5,0-6,8-8,5-10,2		



Ref. 3100 + 1015 Zirkonio

14 Pcs

Cont.	N° Art. Zirkonio	€
Machos Taps / Tarauds DIN 371: M3-M4-M5- M6-M8-M10 + DIN 376: M12	56424	
Brocas Drill Bits / Forets Zirkonio: 2,5-3,3-4,2- 5,0-6,8-8,5-10,2		

Sets 3150

MACHO HELICOIDAL MÁQUINA MÉTRICA MANGO REFORZADO

Reinforced Shank Metric Machine Spiral Tap

Taraud helicoidal machine métrique queue renforcée



Ref. 3150

7 Pcs

Cont.	N° Art. 5% Co	€
Machos Taps / Tarauds DIN 371: M3-M4-M5- M6-M8-M10 + DIN 376: M12	43353	



Ref. 3150 + 1010 HSS

14 Pcs

Cont.	N° Art. HSS	€
Machos Taps / Tarauds DIN 371: M3-M4-M5- M6-M8-M10 + DIN 376: M12	43359	
Brocas Drill Bits / Forets HSS: 2,5-3,3-4,2-5,0- 6,8-8,5-10,2		



Ref. 3150 + 1016 HSSE

14 Pcs

Cont.	N° Art. 5% Co	€
Machos Taps / Tarauds DIN 371: M3-M4-M5- M6-M8-M10 + DIN 376: M12	21802	
Brocas Drill Bits / Forets HSSE: 2,5-3,3-4,2- 5,0-6,8-8,5-10,2		



Ref. 3150 + 1015 Zirkonio

14 Pcs

Cont.	N° Art. Zirkonio	€
Machos Taps / Tarauds DIN 371: M3-M4-M5- M6-M8-M10 + DIN 376: M12	56428	
Brocas Drill Bits / Forets Zirkonio: 2,5-3,3-4,2- 5,0-6,8-8,5-10,2		



Sets
3143-3153

MACHO MÁQUINA MÉTRICA MATERIALES ALEADOS MANGO REFORZADO
Reinforced Shank Alloy Materials Metric Machine Tap
Taraud machine métrique matériaux alliages queue renforcée

Ref. 3143 + 1016 HSSE

MACHO **RECTO**
Straight Tap / Taraud **Droit**



10 Pcs

Cont.	N° Art. 5% Co	€
Machos / Taps / Tarauds DIN 371: M4-M5-M6-M8-M10	82434	
Brocas / Drill Bits / Forets 1016 HSSE: 3,3-4,2-5,0-6,8-8,5		



Ref. 3153 + 1016 HSSE

MACHO **HELICOIDAL**
Spiral Tap / Taraud **Helicoidal**



10 Pcs

Cont.	N° Art. 5% Co	€
Machos / Taps / Tarauds DIN 371: M4-M5-M6-M8-M10	10555	
Brocas / Drill Bits / Forets 1016 HSSE: 3,3-4,2-5,0-6,8-8,5		

Este set, tanto en la versión de machos rectos para agujeros pasantes, como en la versión de machos helicoidales para agujeros ciegos, es la combinación más versátil para trabajos de alto rendimiento. La broca ref. 1016 de cobalto y los machos de vanadio aseguran rendimientos óptimos para todo tipo de materiales.

We are recommending this set due to its versatility in high performance machining. Both in straight version (through holes) and the spiral version (blind holes), our best seller cobalt drill ref. 1016 and the high grade vanadium taps guarantee an optimum performance for any type of material.

On recommande ce set surtout pour travaux d'haute rendement. Le set est disponible bien avec des tarauds droits pour trous passants ou bien avec des tarauds hélicoïdaux pour trous borgnes. Le foret ref. 1016 avec 5% cobalt et les tarauds au vanadium assurent rendements optimaux pour tout type de matériels.



Sets 3125

MACHO RECTO MÁQUINA MÉTRICA INOX GRAN RENDIMIENTO M. REFORZADO
 Reinforced Shank High Performance **Stainless** Metric Machine Straight Tap
 Taraud droit machine métrique **inox** haut rendement queue renforcée

Ref. 3125 + 1016 TIALSIN



10 Pcs

Cont.	N° Art. TIALSIN	€
Machos / Taps / Tarauds DIN 371: M4-M5-M6-M8-M10	32669	
Brocas / Drill Bits / Forets 1016 TIALSIN: 3,3-4,2-5,0-6,8-8,5		

Ref. 3125 + 1020 HSSE



10 Pcs

Cont.	N° Art. 5% Co	€
Machos / Taps / Tarauds DIN 371: M4-M5-M6-M8-M10	32674	
Brocas / Drill Bits / Forets 1020 HSSE: 3,3-4,2-5,0-6,8-8,5		

Sets 3165

MACHO HELICOIDAL MÁQUINA MÉTRICA INOX GRAN RENDIMIENTO M. REFORZADO
 Reinforced Shank High Performance **Stainless** Metric Machine Spiral Tap
 Taraud hélicoïdal machine métrique **inox** haut rendement queue renforcée

Ref. 3165 + 1016 TIALSIN



10 Pcs

Cont.	N° Art. TIALSIN	€
Machos / Taps / Tarauds DIN 371: M4-M5-M6-M8-M10	32675	
Brocas / Drill Bits / Forets 1016 TIALSIN: 3,3-4,2-5,0-6,8-8,5		

Ref. 3165 + 1020 HSSE



10 Pcs

Cont.	N° Art. 5% Co	€
Machos / Taps / Tarauds DIN 371: M4-M5-M6-M8-M10	32670	
Brocas / Drill Bits / Forets 1020 HSSE: 3,3-4,2-5,0-6,8-8,5		



Set **3039**

MACHO ÚNICO MANO MÉTRICA / MÉTRICA FINA NORMA ISO
ISO Standard Metric / Metric Fine Hand Single Tap
Taraud à main unique métrique / métrique pas fin norme ISO

New!

Ref. 3039 + 1015 Zirkonio



14 Pcs

Cont.	N° Art. Zirkonio	€
Machos / Taps / Tarauds ISO 529: M3-M4-M5-M6-M8-M10-M12	26020	
Brocas / Drill Bits / Forets Zirkonio: 2,5-3,3-4,2-5,0-6,8-8,5-10,2		



Amélioration continue du contrôle qualité

izartool.com/fr

Set **3405****JUEGO MACHOS MANO MÉTRICA**

Metric Hand Tap Set

Jeu de tarauds à main métrique

**29 Pcs****Cont.**

Juegos Machos Tap Sets Jeux Tarauds	M3-M4-M5-M6-M8-M10-M12
Brocas Drill Bits Forets mm	2,5-3,3-4,2-5,0-6,8-8,5-10,2
Gira-Machos Tap-Wrench Porte-Tarauds	M1-M12
Destornillador Screwdriver Tournevis	1 pc

N° Art. HSS	€
69624	

Set **3404****JUEGO MACHOS MANO PERFIL ROSCA COMPLETA****Whole Thread Profile** Hand Tap SetJeu de tarauds à main **profil filetage complet****15 Pcs****Cont.**

Macho Taps Tarauds (Ref. 3023)	M3-M4-M5-M6-M8-M10-M12
Brocas Drill Bits Forets mm	2,5-3,3-4,2-5,0-6,8-8,5-10,2
Gira-Machos Tap-Wrench Porte-Tarauds	M1-M12

N° Art. HSS	€
68214	

Sets **3406****JUEGO MACHOS Y COJINETES MANO MÉTRICA**

Metric Hand Tap & Die Set

Jeu de tarauds et filières à main métrique

33 Pcs

Mod. 0 - Cont.

Juegos Machos Tap Sets / Jeux Tarauds	M3-M4-M5-M6-M8-M10-M12
Gira-Machos Tap-Wrench / Porte-Tarauds	M1-M12
Gira-Machos Tap-Wrench / Porte-Tarauds	Criqué M3-M10 Ratchet
Cojinetes Dies / Filières	M3-M4-M5-M6-M8-M10-M12
Porta-Cojinetes Die Holder / Porte-Filières	25x9
Galga Gauge / Gabarit	1 pc
Destornillador Screwdriver / Tournevis	1 pc



Nº Art. HSS	€
70527	

New! ISO

Nº Art. HSS	€
18959	

55 Pcs

Mod. 1 - Cont.

	Nº Art. HSS	€
Juegos Machos Tap Sets / Jeux Tarauds	M3-M4-M5-M6-M8-M10-M12-M14-M16-M18-M20	
Gira-Machos Tap-Wrench / Porte-Tarauds	M1-M12, M5-M20	
Gira-Machos Tap-Wrench / Porte-Tarauds	Criqué M3-M10 + M5-M12 Ratchet	
Cojinetes Dies / Filières	M3-M4-M5-M6-M8-M10-M12-M14-M16-M18-M20	38404
Porta-Cojinetes Die Holder / Porte-Filières	20x5, 20x7, 25x9, 30x11, 38x14, 45x18	
Galga Gauge / Gabarit	1 pc	
Destornillador Screwdriver / Tournevis	1 pc	

**45 Pcs**

Mod. 2 - Cont.

	Nº Art. HSS	€
Juegos Machos Tap Sets / Jeux Tarauds	M3-M4-M5-M6-M8-M10-M12	
Gira-Machos Tap-Wrench / Porte-Tarauds	M1-M10, M4-M12	
Gira-Machos Tap-Wrench / Porte-Tarauds	Criqué M3-M10 Ratchet	
Cojinetes Dies / Filières	M3-M4-M5-M6-M8-M10-M12	
Porta-Cojinetes Die Holder / Porte-Filières	20x5, 20x7, 25x9, 30x11, 38x14	
Galga Gauge / Gabarit	1 pc	
Destornillador Screwdriver / Tournevis	1 pc	
Brocas Drill Bits / Forets mm	2,5-3,3-4,2-5,0-6,8-8,5-10,2	

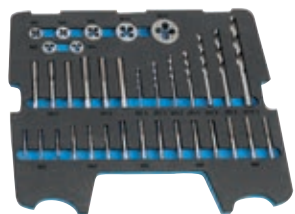



Set **3536**

COJINETE MANO MÉTRICA INOX

Stainless Metric Hand Die
Filière à main métrique **inox**

7 Pcs

Cont.	N° Art. 5% Co	€
Cojinetes / Dies / Filières DIN 223: M3-M4-M5- M6-M8-M10-M12	76494	



Set **3500**

COJINETE MANO MÉTRICA

Metric Hand Die
Filière à main métrique

7 Pcs

Cont.	N° Art. HSS	€
Cojinetes / Dies / Filières DIN 223: M3-M4-M5- M6-M8-M10-M12	56518	

Set **3006**

JUEGO TERRAJAS MONOBLOCK Y MACHOS MANO

Monoblock Die & Hand Tap Set
Jeu filières monoblock & tarauds à main

30 Pcs

Cont.	N° Art.	€
Juegos Machos Tap Sets / Jeux Tarauds M3 - M4 - M5- M6 - M8 - M10 - M12	78141	
Terrajas / Dies / Filières Monoblock Ref. 3005 M3 - M4 - M5- M6 - M8 - M10 - M12		
Gira-Machos Tap-Wrench / Porte- Tarauds M1 - M12		
Galga Gauge / Gabarit 1 pc		



- Diseño especial de terraja monoblock con guía para un roscado más eficiente
- Die with an specially designed guide for an improved threading
- Design spécial des filières monoblock avec guide pour un taraudage plus efficace



Set **1610**

BROCA-MACHO-AVELLANADOR

Combi Tap With Countersink
Outil multi-fonction



7 Pcs

Cont. Ø	N° Art. HSS	€
M3-M4-M5-M6-M8- M10-Adapt.	11025	



Set **3310****SET REPARACIÓN ROSCAS**

Thread Repair Set

Set filet rapportés

**95 Pcs**

Cont. M5-M12			Nº Art.	€
Insertos Inserts Rapportés	<div style="border: 1px solid black; padding: 2px;">INOX 304</div>	M5 0,80 5 pcs 1xD + 5 pcs 1,5xD + 5 pcs 2,5XD	56481	
		M6 1,00 5 pcs 1xD + 5 pcs 1,5xD + 5 pcs 2,5XD		
		M8 1,25 5 pcs 1xD + 5 pcs 1,5xD + 5 pcs 2,5XD		
		M10 1,50 5 pcs 1xD + 5 pcs 1,5xD + 5 pcs 2,5XD		
		M12 1,75 5 pcs 1xD + 5 pcs 1,5xD + 5 pcs 2,5XD		
Brocas Drill Bits Forets (D mm)	<div style="border: 1px solid black; padding: 2px;">HSS</div>	5,20 - 6,30 - 8,30 - 10,40 - 12,50		
Machos Taps Tarauds (D mm)	<div style="border: 1px solid black; padding: 2px;">HSS</div>	6,04 - 7,30 - 9,62 - 11,95 - 14,27		
Insertadores Fitting Tools Appareils de pose (D mm)		4,00 - 4,50 - 6,25 - 7,20 - 9,50		
Rompe arrastres Pin-Breakers Rupteurs (D mm)		4,00 - 4,50 - 6,25 - 7,20 - 9,50		

Set **3311****SET REPARACIÓN ROSCAS BUJÍAS**

Spark Plug Thread Repair Set

Set filet rapportés bougies

**94 Pcs**

Cont. M6-MF14			Nº Art.	€
Insertos Inserts Rapportés	<div style="border: 1px solid black; padding: 2px;">INOX 304</div>	M6 1,00 5 pcs 1xD + 5 pcs 1,5xD + 5 pcs 2,5XD	56482	
		M8 1,25 5 pcs 1xD + 5 pcs 1,5xD + 5 pcs 2,5XD		
		M10 1,50 5 pcs 1xD + 5 pcs 1,5xD + 5 pcs 2,5XD		
		M12 1,75 5 pcs 1xD + 5 pcs 1,5xD + 5 pcs 2,5XD		
		MF14 1,25 5 pcs 1xD + 5 pcs 1,5xD + 5 pcs 2,5XD		
Brocas Drill Bits Forets (D mm)	<div style="border: 1px solid black; padding: 2px;">HSS</div>	6,30 - 8,30 - 10,40 - 12,50		
Machos Taps Tarauds (D mm)	<div style="border: 1px solid black; padding: 2px;">HSS</div>	7,30 - 9,62 - 11,95 - 14,27 - 15,60		
Insertadores Fitting Tools Appareils de pose (D mm)		4,50 - 6,25 - 7,20 - 9,50 - 11,00		
Rompe arrastres Pin-Breakers Rupteurs (D mm)		4,50 - 6,25 - 7,20 - 9,50 - 11,00		

Set **3312****SET REPARACIÓN ROSCAS COMPLETO**

Complete Thread Repair Set

Set filet rapportés complet



19 Pcs

M	P	INOX 304 Insertos Inserts Rapportés	HSS Brocas Drill Bits Forets (D mm)	HSS Machos Taps Tarauds (D mm)	Insertadores Fitting Tools Appareils de pose (D mm)	Rompe arrastres Pin-Breakers Rupteurs (D mm)	Nº Art.	€
M3	0,50	5 pcs 1xD + 5 pcs 1,5xD + 5 pcs 2,5xD	3,20	3,65	2,20	2,20	60330	
M4	0,70	5 pcs 1xD + 5 pcs 1,5xD + 5 pcs 2,5xD	4,20	4,91	3,00	3,00	56484	
M5	0,80	5 pcs 1xD + 5 pcs 1,5xD + 5 pcs 2,5xD	5,20	6,04	4,00	4,00	56487	
M6	1,00	5 pcs 1xD + 5 pcs 1,5xD + 5 pcs 2,5xD	6,30	7,30	4,90	4,90	56488	
M7	1,00	5 pcs 1xD + 5 pcs 1,5xD + 5 pcs 2,5xD	7,30	8,30	4,90	4,90	67804	
MF8	1,00	5 pcs 1xD + 5 pcs 1,5xD + 5 pcs 2,5xD	8,30	9,30	6,50	6,50	56497	
M8	1,25	5 pcs 1xD + 5 pcs 1,5xD + 5 pcs 2,5xD	8,30	9,62	6,50	6,50	56490	
New! MF10	1,00	5 pcs 1xD + 5 pcs 1,5xD + 5 pcs 2,5xD	10,30	11,30	7,00	7,00	12675	
MF10	1,25	5 pcs 1xD + 5 pcs 1,5xD + 5 pcs 2,5xD	10,30	11,62	7,00	7,00	56500	
M10	1,50	5 pcs 1xD + 5 pcs 1,5xD + 5 pcs 2,5xD	10,40	11,95	7,00	7,00	56493	
MF12	1,00	5 pcs 1xD + 5 pcs 1,5xD + 5 pcs 2,5xD	12,30	13,30	9,50	9,50	57967	
MF12	1,50	5 pcs 1xD + 5 pcs 1,5xD + 5 pcs 2,5xD	12,50	13,95	9,50	9,50	57964	
M12	1,75	5 pcs 1xD + 5 pcs 1,5xD + 5 pcs 2,5xD	12,50	14,27	9,50	9,50	56496	
MF14	1,25	5 pcs 1xD + 5 pcs 1,5xD + 5 pcs 2,5xD	* 14,30	15,62	11,00	11,00	57973	
M14	2,00	5 pcs 1xD + 5 pcs 1,5xD + 5 pcs 2,5xD	* 14,50	16,60	11,00	11,00	57970	
New! MF16	1,50	5 pcs 1xD + 5 pcs 1,5xD + 5 pcs 2,5xD	* 16,50	18,00	12,75	12,75	23220	
New! M16	2,00	5 pcs 1xD + 5 pcs 1,5xD + 5 pcs 2,5xD	* 16,50	18,60	12,75	12,75	23221	

* Diámetro de broca correspondiente. Broca no incluida

Corresponding drill bit diameter. Drill bit not included

Diamètre de foret correspondant. Foret non inclus



Set **9016**

ROMPEMACHOS
Tap-Breaker
Foret pour enlever les tarauds cassés

BROCA METAL DURO
DESTRUCTORA MACHOS
Tap Destroyer Solid Carbide Drill Bit
Foret carbure destructeur de tarauds

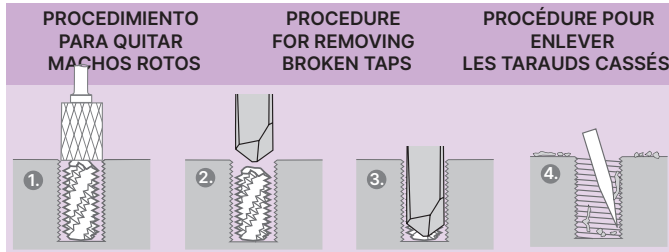

5 Pcs

Cont.	N° Art. MD/HM	€
2-3-4-5-6 mm	83426	Set Price!

D mm	d mm	L mm	l mm	Macho Tap - Taraud
2,00	3,00	38	10	M3
3,00	3,00	38	15	M4 - M5
4,00	4,00	50	20	M6
5,00	5,00	50	25	M8 - M10
6,00	6,00	60	30	M12

Set **9416**

FRESA METAL DURO 1Z
PULIDO ESPEJO ALUMINIO/TERMOPLÁSTICOS
Aluminium/Thermoplastics 1Z Mirror Polished
Carbide End Mill

Fraise carbure 1Z polyglass
Aluminium/Thermoplastiques



5 Pcs

Cont.	N° Art. MD/HM	€
3-4-5 6-8 mm	78335	Set Price!

Set **9459**

FRESA METAL DURO 1Z GRABADO
1Z Engraving Carbide End Mill
Fraise carbure 1Z gravure



4 Pcs

Cont. Ø	N° Art. MD/HM	€
0,1 mm 30° 0,2 mm 30° 0,4 mm 30° 0,8 mm 30°	81958	Set Price!

4 Pcs

Cont. Ø	N° Art. MD/HM	€
0,1 mm 30° 0,1 mm 45° 0,1 mm 60° 0,1 mm 90°	81959	Set Price!

+ info: Cat. IND-24



Sets 9200

JUEGOS FRESAS ROTATIVAS MD HM Rotary Burr Sets Jeux fraises limes rotatives carbure



Mod. 1
5 Pcs



MAT. NO FERROSOS
Non-Ferrous Mat.
Mat. non ferreux



MATERIALES DUROS
Hard Materials
Matériaux Durs

Cont. (1 x ref.)	D mm	d mm	Dentado Teeth / Denture 1		Dentado Teeth / Denture 6	
			Nº Art.	€	Nº Art.	€
9260						
9251	12,70	6,00	60052		45810	
9255						
9258	9,60	6,00			68857	
9266						



Mod. 2
10 Pcs



MATERIALES DUROS
Hard Materials
Matériaux Durs

Cont. (1 x ref.)	D mm	d mm	Dentado Teeth / Denture 6	
			Nº Art.	€
9260				
9250				
9251				
9254				
9255	6,00	6,00	45811	
9257				
9258				
9266				
9267				
9268				



Mod. 3
8 Pcs



MATERIALES DUROS
Hard Materials
Matériaux Durs

Cont. (1 x ref.)	D mm	d mm	Dentado Teeth / Denture 6	
			Nº Art.	€
9260				
9250				
9251				
9254	3,00	3,00	45813	
9257				
9258				
9267				
9268				



Mod. 4
3 Pcs



MATERIALES DUROS
Hard Materials
Matériaux Durs

Cont. (1 x ref.)	D mm	d mm	Dentado Teeth / Denture 6	
			Nº Art.	€
9260				
9251	9,60	6,00	79826	
9254				



New!
Mod. 5
5 Pcs



INOXIDABLES
Stainless Steels
Aciers Inox

Cont. (1 x ref.)	D mm	d mm	Dentado Teeth / Denture M	
			Nº Art.	€
9251				
9254	12,70	6,00	84379	
9257				
9258	9,60	6,00	84380	
9268				



Box-Pallet
9201

JUEGOS FRESAS ROTATIVAS MD CALIDAD PROFESIONAL
Professional Quality HM Rotary Burr Sets
Jeux fraises limes rotatives carbure qualité professionnelle

New!



6 Sets

Nº Art.	€
58925	



Set 8 Pcs

Nº Art.	€
58922	

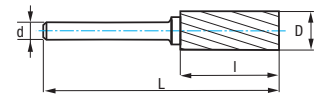

Cont.

Tipo Type	D mm	d mm	L mm	I mm
D	6	6	52	5
	10	6	53	9
C	6	6	61	16
	10	6	65	20
F	10	6	65	20
	12	6	70	25
B	10	6	65	20
	12	6	70	25



6 Sets

Nº Art.	€
58928	



Set 10 Pcs

Nº Art.	€
58920	

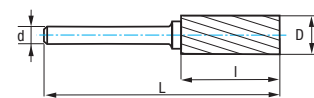

Cont.

Tipo Type	D mm	d mm	L mm	I mm
L	6	6	61	16
	10	6	70	25
F	6	6	63	18
	10	6	65	20
B	6	6	61	16
	10	6	65	20
C	6	6	61	16
	10	6	65	20
E	6	6	61	16
D	8	6	52	7



Set **1489**

BROCA-MARTILLO SDS PLUS 4Z+
4Z+ Cutter SDS plus Rotary Hammer Drill Bit
Foret percussion SDS plus 4Z+



Ref. 1891



Video

7 Pcs

Cont. Ø	Nº Art.	€
5-6-8 × 115 + 6-8-10-12 × 165 mm	39851	

BROCA-MARTILLO SDS PLUS
SDS plus Rotary Hammer Drill Bit
Foret percussion SDS plus

Set **1494**

4 Pcs

Cont. Ø	Nº Art.	€
5×110 6×110 8×160 10×160 mm	11528	



Ref. 1890

Set **1497**

7 Pcs

Cont. Ø	Nº Art.	€
5-6-8 × 110 + 6-8-10-12 × 160 mm	11529	



Ref. 1890

Set **1879**

BROCA-CORONA DIAMANTE PORCELÁNICO
Porcelain Diamond Core Bit
Foret-Trépan diamant **PORCELAINE**



Usos / Use / Usage



5 Pcs

Cont. Ø	Nº Art.	€
5-6-8-10-12 mm	57448	

Set **1482**

BROCA PORCELÁNICO
PORCELAIN Drill Bit
Foret **PORCELAINE**



Ref. 1882



Video

4 Pcs

Cont. Ø	Nº Art.	€
4-5-6-8 mm	31004	



Sets **1876**

BROCA PUNTA METAL DURO MULTIPROPÓSITO

MultiPurpose Carbide Tipped Drill Bit
Foret pointe carbure Multifonction

New!

Una broca para **TODOS** los materiales
One Drill Bit for **ALL** Materials - Un foret pour **TOUS** les matériaux



▶ Video



6 Pcs

Cont. Ø	Nº Art.	€
3-4-5-6-8-10 mm	70478	



6 Sets

Nº Art.	€
53481	

Sets **1821**

BROCA PUNTA METAL DURO PARED PRO 4Z+ MANGO 3 PLANOS

3-Flat Shank 4Z+ Professional Concrete Carbide Tipped Drill Bit
Foret pointe carbure béton professionnel 4Z+ queue 3 plans

New!



5 Pcs

D mm	Nº Art.	€
5, 6, 8, 10, 12	69406	



6 Sets

Nº Art.	€
69408	

BROCA PUNTA METAL DURO PARED PROFESIONAL

Professional Concrete Carbide Tipped Drill Bit
Foret pointe carbure béton professionnel

Set **1486**

5 Pcs

Cont. Ø	Nº Art.	€
4-5-6-8-10 mm	30220	



Ref. 1886

Set **1487**

8 Pcs

Cont. Ø	Nº Art.	€
3-4-5-6-7-8-9-10 mm	21653	



Ref. 1886



Construcción - Construction - Construction

BROCA PUNTA METAL DURO PARED STANDARD

Standard MASONRY Carbide Tipped Drill Bit

Foret Pointe carbure MAÇONNERIE standard

Set
1485

5 Pcs

Cont. Ø	Nº Art.	€
4-5-6-8-10 mm	30215	



Ref. 1880

Set
1488

8 Pcs

Cont. Ø	Nº Art.	€
3-4-5-6-7-8-9-10 mm	30219	



Ref. 1880

Set
1836

BROCA VIDRIO

GLASS Drill Bit

Foret VERRE



¡NUEVO MODELO MEJORADO!

New improved model!

Nouveau modèle amélioré !

New!

4 Pcs

Cont. Ø	Nº Art.	€
4-5-6-8 mm		

Set
1460

SET MIXTO BROCAS

Drill Bit Mix Set

Jeu forets mix



9 Pcs

Cont. Ø	Nº Art.	€
3 Pcs Metal: 5-6-8	55610	
3 Pcs Madera/Wood/Bois: 5-6-8		
3 Pcs Pared/Masonry/Béton: 5-6-8		



Construcción - Construction - Construction

Sets **1645****SIERRA CORONA METAL / MADERA**
METAL / WOOD Hole Saw
Trépan **MÉTAL / BOIS****Mod. 1**

7 Pcs

Básico
Basic
Essentiel

Cont. Ø mm	Nº Art.	€
25-35-43-51-64-H3A-H4A	18232	

Mod. 2

14 Pcs

Completo
Complete
Complet

Cont. Ø mm	Nº Art.	€
19-22-25-32-35-38-43-51-57-60-64-76 H3A-H4A	18234	

Mod. 3

12 Pcs

Electricista
Electrician
Electricien

Cont. Ø mm	Nº Art.	€
16-20-25-32-40-43-51-60-63-65-H3A-H4A	18235	

Mod. 4

8 Pcs

Básico 2
Basic 2
Essentiel 2

Cont. Ø mm	Nº Art.	€
16-20-25-32-40-51-H3A-H4A	58617	

Mod. 5

11 Pcs

Electricista 2
Electrician 2
Electricien 2

Cont. Ø mm	Nº Art.	€
16-20-27-32-40-43-48-51-64-H3A-H4A	58618	

Mod. 6

8 Pcs

Electricista 3
Electrician 3
Electricien 3

Cont. Ø mm	Nº Art.	€
22-35-51-57-68-76-H3A-H4A	66889	

Display box

1849

AMARRE RÁPIDO AMOLADORA

Quick Lock Grinding Tool

Attachement rapide meuluse

New!



6 Pcs

Nº Art.	€
24140	

Madera - Wood - Bois

BROCA PUNTA CENTRAR

Center Point Drill Bit

Foret auto-centreur

Set
1435

5 Pcs

Cont. Ø	Nº Art.	€
4-5-6-8-10 mm	30223	



Ref. 1640

Set
1438

8 Pcs

Cont. Ø	Nº Art.	€
3-4-5-6-7-8-9-10 mm	30226	



Ref. 1640

Set
1655

BROCA ESPIRAL TORNILLO EN LA PUNTA

Screw-Point Auger Drill Bit

Foret spirale vis en pointe

New!



9 Pcs

Cont. Ø	Nº Art.	€
4-5-6-8-10-12-14-16-18-mm	19795	





Madera - Wood - Bois

Set **1651**

BROCA PLANA GRAN RENDIMIENTO
Heavy Duty Flat Bit
Mèche plate haut rendement



8 Pcs

Cont. Ø	Nº Art.	€
12-16-18-20-22-25-28-32 mm	57449	

Set **1650**

BROCA PLANA
Flat Bit
Mèche plate



8 Pcs

Cont. Ø	Nº Art.	€
12-16-18-20-22-25-28-32 mm	66378	

Set **1620**

SET BROCA-FRESA
Forstner bits set
Jeu de mèches à façonner

New!



8 Pcs

Cont. Ø	Nº Art.	€
15-20-25-30-35-40-45-50 mm	24630	



Sets **1616**

BROCA MANGO E6.3 MATERIALES DUROS

Hard Materials Cobalt E6.3 Shank Drill Bit
Foret queue E6.3 matériaux durs



New!



6 Sets

N° Art.	€
86261	



Set 5 Pcs

Cont. Ø	N° Art.	€
3-4-5-6-8 mm	35267	



6 Sets

N° Art.	€
86262	



Set 8 Pcs

Cont. Ø	N° Art.	€
3-4-5-6-7-8-9-10 mm	35268	

Sets **1613**

BROCA MANGO E6.3 USO GENERAL

Speed Point E6.3 Shank Drill Bit
Foret queue E6.3 utilisation générale



New!



6 Sets

N° Art.	€
86263	



Set 5 Pcs

Cont. Ø	N° Art.	€
3-4-5-6-8 mm	35269	



6 Sets

N° Art.	€
86264	



Set 8 Pcs

Cont. Ø	N° Art.	€
3-4-5-6-7-8-9-10 mm	35270	



Sets **1614**

BROCA-MACHO-AVELLANADOR MANGO E6.3

E6.3 Shank Combi Tap with Countersink
Outil multi-fonction queue E6.3



6 Sets

Nº Art.	€
84155	



New!



7 Pcs

Cont.	Nº Art.	€
M3-M4- M5-M6- M8-M10- M12	84151	

Sets **1834**

BROCA VIDRIO Y AZULEJO 4Z+

4Z+ Glass and Soft Tiles Drill Bit
Foret verre et carreau 4Z+



6 Sets

Nº Art.	€
69405	



New!



5 Pcs

D mm	Nº Art.	€
5, 6, 8, 10, 12	69403	

Set **1601**

BROCA PUNTA METAL DURO PARED

Masonry Carbide Tipped Drill Bit
Foret pointe carbure maçonnerie



4 Pcs

Cont. Ø	Nº Art.	€
4-5-6-8 mm	59081	

¡NUEVO MODELO MEJORADO!
New improved model!
Nouveau modèle amélioré !



Sets **1520**

PUNTA ATORNILLAR
Screwdriver Bit
Embout vissage

New!

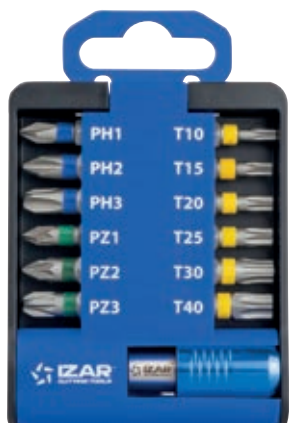

Set 13 Pcs

Cont.	Nº Art.	€
PH: 1 - 2 - 3 +	83769	
PZ: 1 - 2 - 3 +		
T: 10 - 15 - 20 - 25 - 30 - 40		



Display box
1520

12 Sets

Nº Art.	€
83770	

Display box
1520

PUNTAS ATORNILLAR
Screwdriver Bits
Embouts vissage

6 Sets

Nº Art.	€
68168	



Set 31 Pcs

Nº Art.	€
67769	

31
pcs



PH	d mm: 6,35
2x PH1	
3x PH2	
1x PH3	

PZ	d mm: 6,35
2x PZ1	
8x PZ2	
2x PZ3	

Tx	d mm: 6,35
1x T10	
2x T15	
2x T20	
3x T25	
3x T30	
1x T40	

Adapt. Quick-Lock
INOX/Stainless
L mm: 60 - d mm: 6,35



Display box
1510

SET PUNTAS DE PRECISIÓN
Precision Screw Bit Set
Set embouts vissage de précision

New!



6 Sets

Nº Art.	€
21335	

58
pcs

Set 58 Pcs

Nº Art.	€
21334	

48 Puntas / Bits / Embouts material S2

PH	1.0 - 1.5 - 2.0 - 2.5 - 3.0 - 3.5	
HEX	0.9 - 1.3 - 1.5 - 2.0 - 2.5 - 3.0 - 3.5 - 4.0 - 4.5 - 5.0 - 6.0	
TS	2 - 3 - 4 - 5 - 6 - 7 - 8 - 9 - 10 - 15 - 20	
SL	1.0 - 1.5 - 2.0 - 2.5 - 3.0 - 3.5	1.5
P	0.8 - 1.2 - 1.5 - 2.0	SQ 0 - 1 - 2
Y	0.8 - 2.0 - 2.5 - 3.0	TA 2.0 - 2.3

6 Vasos / Sockets / Douilles hex. material CrV

M2.5 - M3.0 - M3.5 - M4.0 - M4.5 - M5.0

2 Adaptadores / Adaptors / Adaptateurs

H4.0 → H6.3	H6.3 → H4.0
-------------	-------------

Destornillador Profesional Aleación de Aluminio

1 Profesional Aluminum Alloy Screwdriver
Tournevis en alliage aluminium

Alargador Flexible
1 Flexible Extension Bar
Rallonge Souple

PUNTAS DE GRADO INDUSTRIAL

- Acero S2 de gran dureza (60 HRC)
- Cuellos largos para un mejor acceso
- Magnéticos

INDUSTRIAL GRADE SCREW BITS

- Shock-resisting S2 Steel (60 HRC)
- Long neck. Suitable for hard-to-reach areas
- Magnetic

EMBOUS À DEGRÉ INDUSTRIEL

- Acier S2 de grande dureté (60 HRC)
- Cous longs pour un meilleur accès
- Magnétiques

Display box
3407

EXTRACTORES IMPACTO
Impact Extractors
Extracteurs impact

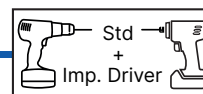

6 Sets

Nº Art.	€
74792	

Set 17 Pcs

Nº Art.	€
72898	

17
pcs



Extractores Impacto
Impact Extractors
Extracteurs impact
N.º 1 - 2 - 3 - 4

d mm: 6,35	
Tx	T10 T15 T20 T25 T30 T40
+	±25 mm

PH d mm: 6,35
PH1
PH2
PH3
±25 mm

Adapt. Quick-Lock
L mm: 60 - d mm: 6,35

PZ d mm: 6,35
PZ1
PZ2
PZ3
±25 mm



Set **3409**



EXTRACTOR TORNILLOS
Screw Extractor
Extracteur vis

5 Pcs

Set P/ Tornillo F/ Screw P/ Vis	P/ Tornillo F/ Screw P/ Vis	Nº Art.	€
M3-M18	1/8-3/4	75905	

Set **1529**



ADAPTADOR MAGNÉTICO PARA TORNILLOS
Magnetic Screw Adaptor
Adaptateur magnetique pour vis

5 Pcs

D mm	L mm	d mm	Nº Art.	€
6-7-8-10-13	65	6,35	69751	

Display box
1461

SET BROCAS MANGO E6.3 Y PUNTAS DE ATORNILLAR
E6.3 Shank Drill Bit and Screwdriver Bit Set
Jeu de forets queue E6.3 et embouts vissage

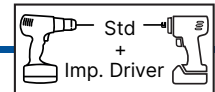

6 Sets

Nº Art.	€
19322	



Set 17 Pcs

Nº Art.	€
82204	



6 Sets

Nº Art.	€
19291	



Set 17 Pcs

Nº Art.	€
81601	

17
pcs

Cont. set

Art. 82204
Brocas Metal
Metal Drill Bits - Forets métal
3- 4 - 5 - 6 mm

Art. 81601
Brocas Madera
Wood Drill Bits - Forets bois
3- 4 - 5 - 6 mm

PH d mm: 6,35
PH1
PH2
PH3
↳25 mm↳

PZ d mm: 6,35
PZ1
PZ2
PZ3
↳25 mm↳

Tx d mm: 6,35
T10
T15
T20
T25
T30
T40
↳25 mm↳

Adapt. Quick-Lock
INOX/Stainless
 L mm: 60 - d mm: 6,35



Set **1461**

SET BROCAS MANGO E6.3 Y PUNTAS DE ATORNILLAR

E6.3 Shank Drill Bit and Screwdriver Bit Set
Jeu de forets queue E6.3 et embouts vissage

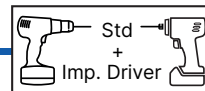

Brocas rectificadas Metal Mango HEX
HEX Shank Metal Ground Drill Bits
Forets rectifiés métal queue HEX
2 - 2,5 - 3 - 3,5 - 4 - 5 - 6 mm

Brocas Pared
Masonry Drill Bits
Forets maçonnerie
4 - 5 - 6 - 8 mm

Brocas Madera
Wood Drill Bits
Forets bois
3 - 4 - 5 - 6 - 8 mm

42
pcs

Adapt. Quick-Lock
INOX/Stainless

L mm: 60 - d mm: 6,35
1 pc.

Cuter Hoja Partible
Snap-Off Box Cutter
Cou-teaux à lames rétractables
1 pc.

Nº Art. €
79873

Puntas Atornillar / Screwdriver Bits / Embouts vissage

PH d mm: 6,35 PH1 PH2 PH3 ↳25 mm↳	d mm: 6,35 T10 T15 T20 T25 T27 T30 T40 ↳25 mm↳	d mm: 6,35 SL 4 SL 5,5 SL 6,5 ↳25 mm↳
d mm: 6,35 PZ1 PZ2 PZ3 ↳25 mm↳	d mm: 6,35 H3 H4 H5 ↳25 mm↳	d mm: 6,35 TS15 TS20 TS25 TS30 TS40 ↳25 mm↳

Set **1461**

SET BROCAS Y PUNTAS ATORNILLAR

Drill Bit & Screwdriver Bit Set
Jeu de forets et embouts vissage



72
pcs

Brocas Metal
Metal Drill Bits
Forets Métal
2 - 3 - 4 - 5 - 6 - 8 mm

Brocas Pared
Masonry Drill Bits
Forets Maçonnerie
4 - 5 - 6 - 8 mm

Brocas Madera
Wood Drill Bits
Forets Bois
3 - 4 - 5 - 6 - 8 mm

Adapt. Magnético
Magnetic Adapt.
Adapt. Magnétique
6 - 7 - 8
10 - 13 mm

Adapt. Quick-Lock
INOX/Stainless

L mm: 60 - d mm: 6,35
1 pc.

Cuter Hoja Partible
Snap-Off Box Cutter
Cou-teaux à lames rétractables
1 pc.

Puntas Atornillar / Screwdriver Bits / Embouts Vissage

d mm: 6,35 3x PH1 4x PH2 3x PH3 ↳25 mm↳	d mm: 6,35 T5 - T6 2x T10 T15 3x T20 4x T25 T27 3x T30 2x T40 ↳25 mm↳	d mm: 6,35 SL 4 SL 4,5 SL 5,5 SL 6 SL 6,5 ↳25 mm↳
d mm: 6,35 3x PZ1 4x PZ2 2x PZ3 ↳25 mm↳	d mm: 6,35 SQ 1 SQ 2 SQ 3 ↳25 mm↳	d mm: 6,35 H2 H3 H4 H5 H6 ↳25 mm↳

Nº Art. €
78504



Sets 2900

SETS MULTI-FUNCIÓN Oscillating Multi-Tool Sets Jeux de outils multifonction

Refs.
2940-2910

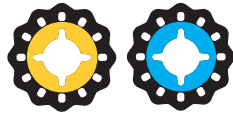

**Ref. 2940
(MADERA-Wood-Bois)
+
Ref. 2910 (METAL)**

4 Pcs

Cont.	Nº Art.	€
Ref. 2940: Mod. 00030	69702	
Ref. 2910: Mods. 00020- 00060-00070		

Ref.
2930



**ESPECIAL
Special
Spécial**

4 Pcs

Cont.	Nº Art.	€
Ref. 2930: Mods. 00020- 00060- 00070-00080	69704	

Sets 3415

ACEITES DE CORTE Y REFRIGERANTES Cutting Oils & Water Soluble Fluids Huiles de coupe et lubrifiants

New!

9×250ml
UNI

Nº Art.	€
13929	Set Price!



UNI
Universal



UNI+INOX+ALU
3+3+3×250ml
MIXTO

Nº Art.	€
13930	Set Price!



UNI INOX ALU
Universal Heavy Duty Non Ferrous



6×400ml
AEROSOL

Nº Art.	€
13912	Set Price!



UNI
Universal



ACEITES DE CORTE Y REFRIGERANTES Cutting Oils & Water Soluble Fluids Huiles de coupe et lubrifiants



UNI INOX ALU STD TOP MULTI
Universal Heavy Duty Non Ferrous Standard Top Line Multiusos

Consulte gama completa
See the full range
Voir toute la gamme



Display box
8320

CUTER HOJA PARTIBLE 18 MM
18 mm Snap-Off Blade Box Cutter
Couteau à lames rétractables 18 mm

New! MOD. 18-ERG



Ref.
8318

24 Pcs

Nº Art.	€
10177	

CUCHILLAS REPUESTO
Spare Blades - Lames de rechange

New!



20 uds

Nº Art.	€
12676	

Display box
8320

CUTER HOJA SEGURIDAD 19 MM
19 mm Security Blade Box Cutter
Couteau à lame sécurité 19 mm

New! MOD. 19S-RET



Ref.
8319

6 Pcs

Nº Art.	€
10174	

CUCHILLAS REPUESTO - Spare Blades - Lames de rechange

New!



20 uds

Nº Art.	€
12677	

New!



20 uds

Nº Art.	€
12682	



Sets 8391

PINZAS DE SUJECIÓN ER DE ALTA PRECISIÓN

High Precision ER Collets

Pinces de fixation ER haute précision

New!



Clase
Class Classe
A

Tol.
↗ **0,01**
mm

DIN
6499 B



Set	Pcs	Cont.	N° Art.	Set Price!
ER11	13	1 - 1,5 - 2 - 2,5 - 3 - 3,5 - 4 - 4,5 - 5 - 5,5 - 6 - 6,5 - 7	24563	
ER16	10	1 - 2 - 3 - 4 - 5 - 6 - 7 - 8 - 9 - 10	24571	
ER20	12	2 - 3 - 4 - 5 - 6 - 7 - 8 - 9 - 10 - 11 - 12 - 13	24575	
ER25	15	2 - 3 - 4 - 5 - 6 - 7 - 8 - 9 - 10 - 11 - 12 - 13 - 14 - 15 - 16	24579	

Set	Pcs	Cont.	N° Art.	Set Price!
ER32	18	3 - 4 - 5 - 6 - 7 - 8 - 9 - 10 - 11 - 12 - 13 - 14 - 15 - 16 - 17 - 18 - 19 - 20	24584	
ER40	24	3 - 4 - 5 - 6 - 7 - 8 - 9 - 10 - 11 - 12 - 13 - 14 - 15 - 16 - 17 - 18 - 19 - 20 - 21 - 22 - 23 - 24 - 25 - 26	24590	

Sets 8392

PINZAS DE SUJECIÓN ESTANCAS ERC DE ALTA PRECISIÓN

High Precision ERC Sealing Collets

Pinces de fixation ERC haute précision

New!



Clase
Class Classe
A

Tol.
↗ **0,01**
mm

DIN
6499 B



Set	Pcs	Cont.	N° Art.	Set Price!
ERC16	8	3 - 4 - 5 - 6 - 7 - 8 - 9 - 10	84006	
ERC20	11	3 - 4 - 5 - 6 - 7 - 8 - 9 - 10 - 11 - 12 - 13	84007	
ERC25	14	3 - 4 - 5 - 6 - 7 - 8 - 9 - 10 - 11 - 12 - 13 - 14 - 15 - 16	84008	

Set	Pcs	Cont.	N° Art.	Set Price!
ERC32	18	3 - 4 - 5 - 6 - 7 - 8 - 9 - 10 - 11 - 12 - 13 - 14 - 15 - 16 - 17 - 18 - 19 - 20	84009	
ERC40	24	3 - 4 - 5 - 6 - 7 - 8 - 9 - 10 - 11 - 12 - 13 - 14 - 15 - 16 - 17 - 18 - 19 - 20 - 21 - 22 - 23 - 24 - 25 - 26	84010	

Sets 8395

PINZAS DE SUJECIÓN DE GRAN APRIETE DE ALTA PRECISIÓN

High Precision Strong Collets

Pinces de fixation de grand serrage haute précision

New!



Clase
Class Classe
A

Tol.
↗ **0,01**
mm



Set	Pcs	Cont.	N° Art.	€ Set Price!
C20	5	6 - 8 - 10 - 12 - 16	25302	
C32	11	4 - 5 - 6 - 8 - 10 - 12 - 14 - 16 - 18 - 20 - 25	25300	

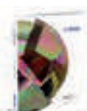

+ info: Cat. IND-24





Top Quality Raw Materials

izartool.com/en



IZAR CUTTING TOOLS, S.A.L.
C.I.F.: A-48932826
Parque Empresarial Boroa 2B2
48340 AMOREBIETA (Bizkaia)
Spain
izartool.com

COMERCIAL NACIONAL ✉ comercial@izartool.com

**PEDIDOS Y
ATENCIÓN A CLIENTES** ☎ 94 630 02 41

SERVICIO TÉCNICO ☎ 94 630 02 43

EXPORT SALES ✉ export@izartool.com

**ORDERS & CUSTOMER
ASSISTANCE** ☎ +34 94 630 02 46

VENTES FRANCE ✉ france@izartool.com
☎ +34 94 630 02 45

VENDITA ITALIA ✉ italia@izartool.com
☎ +34 94 630 02 45



izartool.com



Todas nuestras publicaciones se imprimen en papel ecológico procedente de fuentes responsables con el medioambiente y la sociedad.

All our publications are printed on ecological paper from environmentally and socially responsible sources.

Toutes nos publications sont imprimées sur du papier écologique issu de sources écologiquement et socialement responsables.